

EXPAND

DESIGN BY MARKSLÖJD

107514/107515

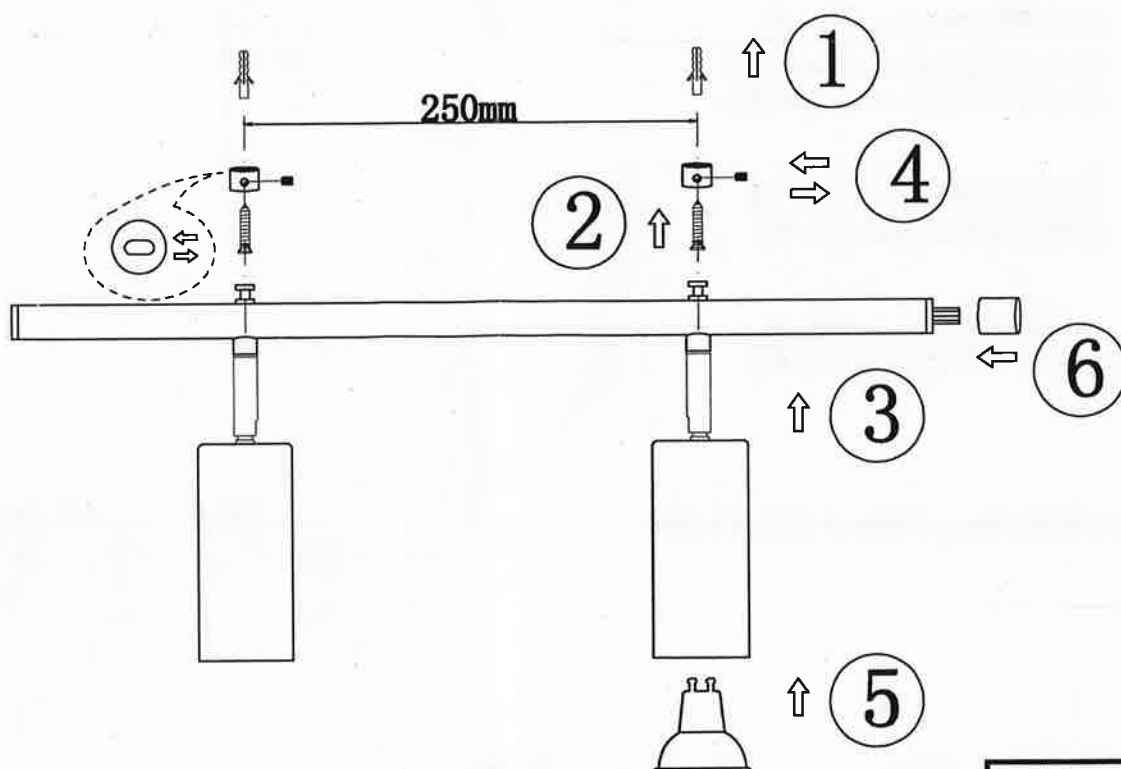
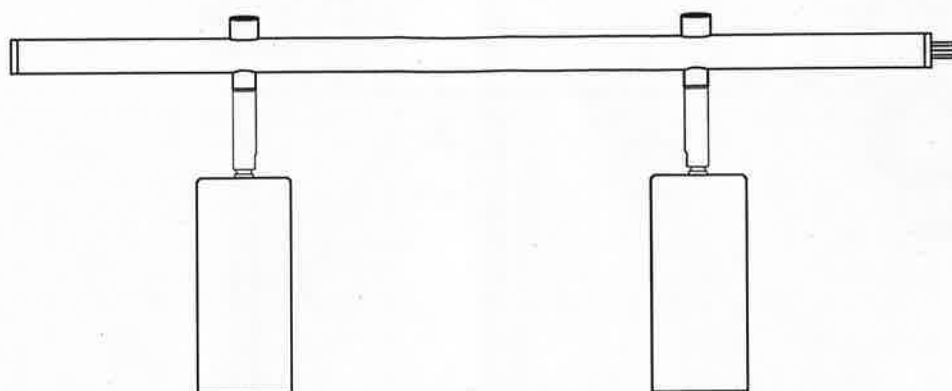

Markslöjd AB
Gränevägen 5 S-511 62 Skene
Sweden
www.markslöjd.com



EXPAND

DESIGN BY MARKSLÖJD

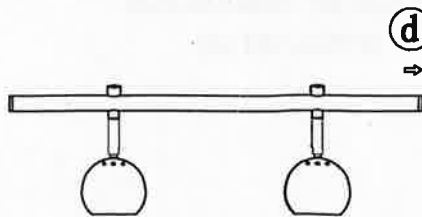
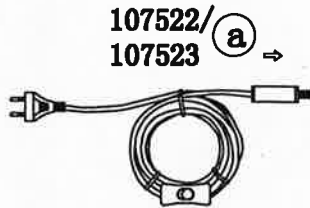

107517/107516..
etc. see below list

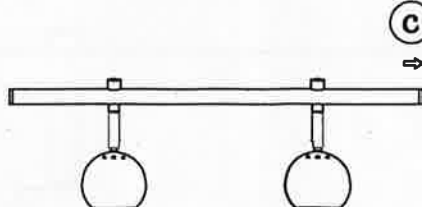
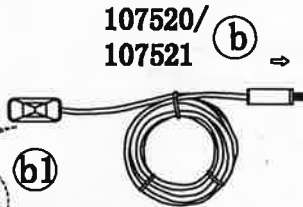
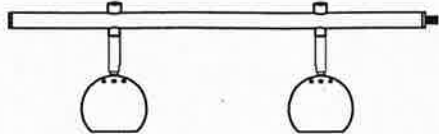

107519/
107518

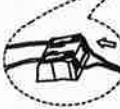
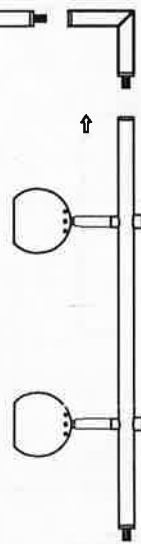

(b1)
2*(0.75-1.5)
double insulation

d: with different head or length

107515 GU10 Cylinder WH 50L
107514 GU10 Cylinder SN 50L



107517 GU10 Round WH 50L
107516 GU10 Round SN 50L



107510 E27 Cylinder SN 50L
107513 E27 Cylinder WH 50L



Important dimensions of drilling holes!

